

Lesson materials pack

Shopping and money

1. Lesson print outs / worksheets



A/B Shop
(Sheet A and
B)

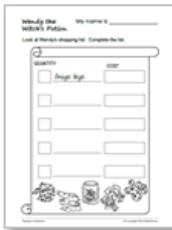

Reader
worksheet



Shopping
Board Game
Sheet 1



Shopping
Board Game
Sheet 2

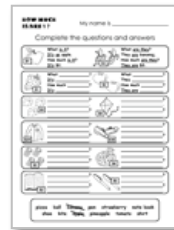

How much is/
are? 1

2. Additional materials *These materials can used for extra practice or homework.*



Shopping
vocab
crossword



Shopping
vocab word
search



Let's go
shopping

3. Lesson materials not included in this pack *Access from our website.*

- **Wendy the Witch's Potion reader:** download PDF file and/or stream the video from our website.

A's Shopping List

Peas	£
Kite	£
Rubber	£
Carrots	£
Cereal	£
Frying Pan	£
Milk	£
Pencil Case	£
TOTAL	£

SAMPLE FOR EVALUATION
Join ESL KidStuff/
to print without watermark

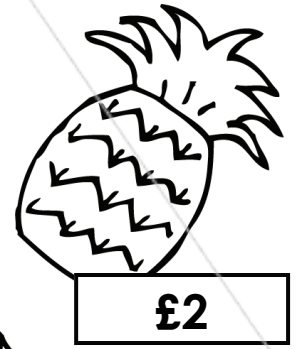
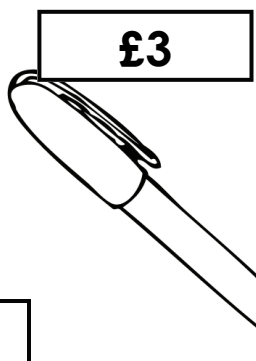
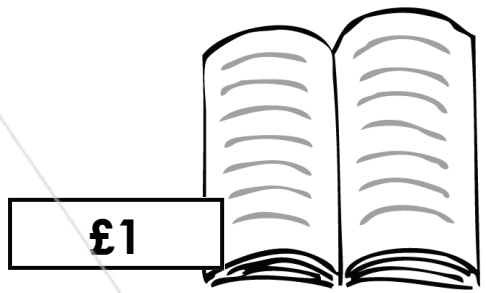
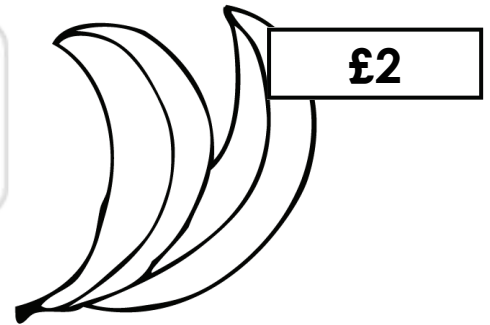

B's Shopping List

Note Book	£
Pineapple	£
Shampoo	£
Pizza	£
Bananas	£
Pen	£
Lettuce	£
Cap	£
TOTAL	£

SAMPLE FOR EVALUATION
Join ESL KidStuff/
to print without watermark



£1

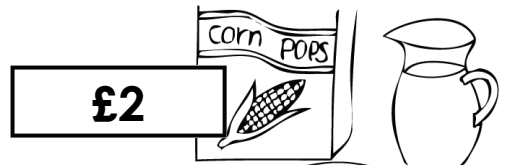

£2

£16

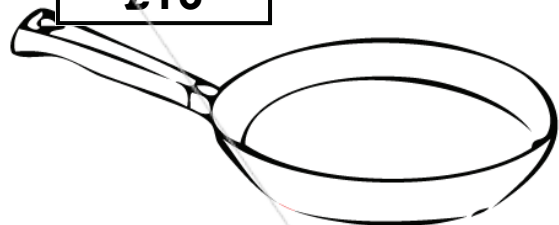

£3

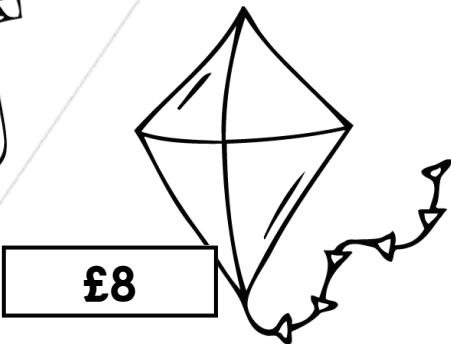
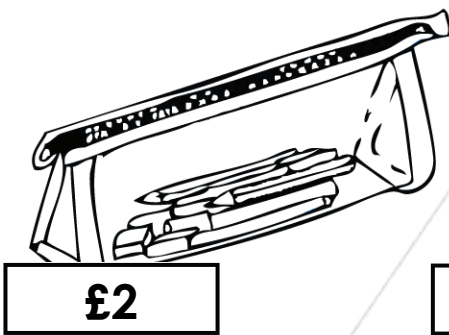
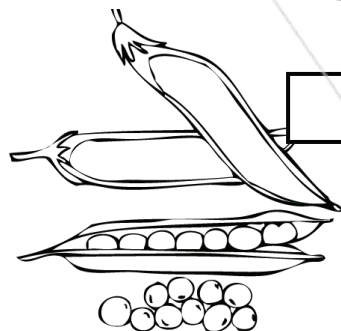

£8

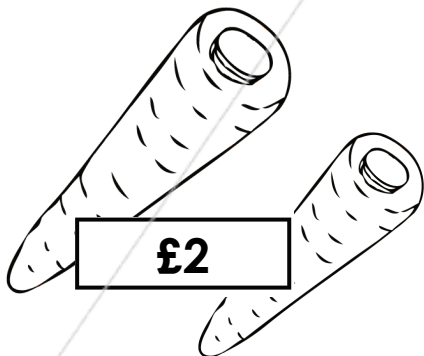

£2

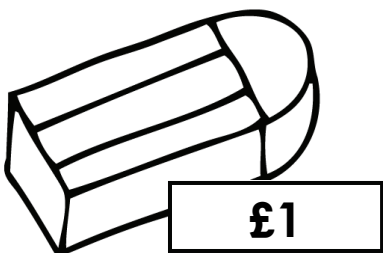

£1

Wendy the Witch's Potion

My name is _____

Look at Wendy's shopping list. Complete the list.

QUANTITY

COST

frogs legs

SAMPLE FOR EVALUATION

Join ESL KidStuff
to print without watermark

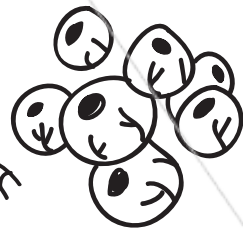
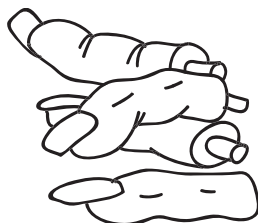

Shopping Game

Sheet 1 (GB)

My name is _____

Use with Sheet 2. Play in pairs. Move around the board in turns. When you land on a square act out the dialogue. Play until one player has bought all the items on their shopping list.

STUDENT A'S SHOPPING LIST

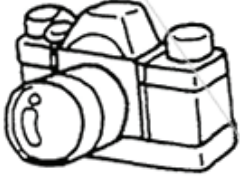

DIALOG

clerk: "May I help you?"
customer: "Yes. A camera please"
clerk: "Do you want a Nikon?"
customer: "Can you print without watermark?"
clerk: "Here you are"
customer: "Thank you. How much is it?"
clerk: "(It's) £300"
customer: "Thank you."
clerk: "You're welcome"

or

clerk: "May I help you?"
customer: "No thank you. (I'm) just looking."









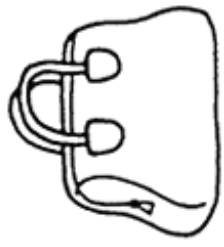

STUDENT B'S SHOPPING LIST

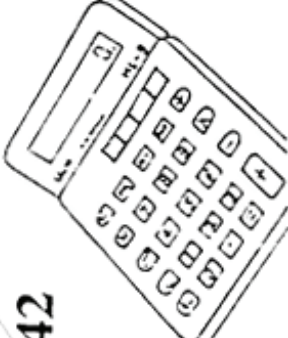

Shopping Game Sheet 2 (GB)

Use with Shopping Game Sheet 1

START ⇒



<p>£300</p>  <p>Canon / Nikon</p>	<p>£47</p>  <p>Black / Brown</p>	<p>£55</p>  <p>tennis shoes / jogging shoes</p>	<p>£3.50</p>  <p>Fuji / Kodak</p>
<p>£75</p>  <p>Seiko / Citizen</p>	<p>SAMPLE FOR EVALUATION Join ESL KidStuff to print without watermark</p>		<p>£42</p>  <p>Casio / Canon</p>
<p>£33</p>  <p>Levi's / Edwin</p>			<p>£200</p>  <p>Man's / Woman's</p>
<p>£120</p>  <p>leather / wool</p>	<p>£22</p>  <p>Large / Small</p>	<p>£15</p>  <p>red / blue</p>	<p>£80</p>  <p>foot ball / volleyball</p>



HOW MUCH IS/ARE 1? (GB)

My name is _____



Complete the questions and answers



 <p>£1</p>	<p>What <u>is it</u>? <u>It's an apple.</u> How much <u>is it</u>? <u>It's £1.</u></p>	 <p>£2</p>	<p>What <u>are they</u>? <u>They are bananas.</u> How much <u>are they</u>? <u>They are £3.</u></p>
--	---	--	--

 <p>£1</p>	<p>What _____? <u>It's _____.</u> How much _____? <u>It's _____.</u></p>	 <p>£2</p>	<p>What _____? <u>They _____.</u> How much _____? <u>They are _____.</u></p>
--	---	--	---

 <p>£3</p>	<p>_____? _____. _____? _____.</p>	 <p>£5</p>	<p>_____? _____. _____? _____.</p>
---	---	---	---

SAMPLE FOR EVALUATION
 Join ESL KidStuff
 to print without watermark

 <p>£13</p>	<p>_____? _____. _____? _____.</p>	 <p>£21</p>	<p>_____? _____. _____? _____.</p>
---	---	---	---

 <p>£2</p>	<p>_____? _____. _____? _____.</p>	 <p>£4</p>	<p>_____? _____. _____? _____.</p>
--	---	--	---

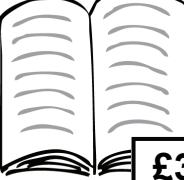
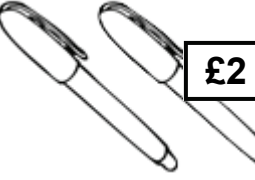
 <p>£3</p>	<p>_____? _____. _____? _____.</p>	 <p>£2</p>	<p>_____? _____. _____? _____.</p>
--	---	--	---

pizza ball ~~banana~~ pen strawberry note book
 shoe kite ~~apple~~ pineapple tomato shirt

Shopping

My name is _____

SAMPLE FOR EVALUATION
Join ESL KidStuff
to print without watermark

Down ↓

Across →

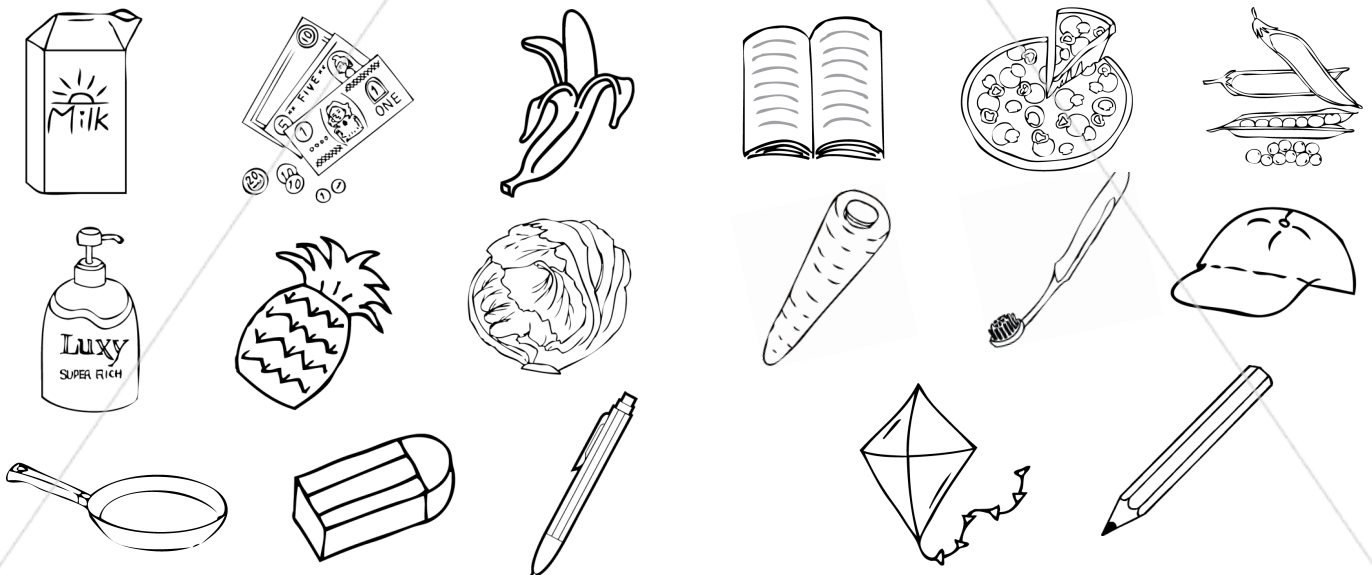

Shopping

ANSWERS

SAMPLE FOR EVALUATION
 Join ESL KidStuff
 to print without watermark

Down ↓

Across →

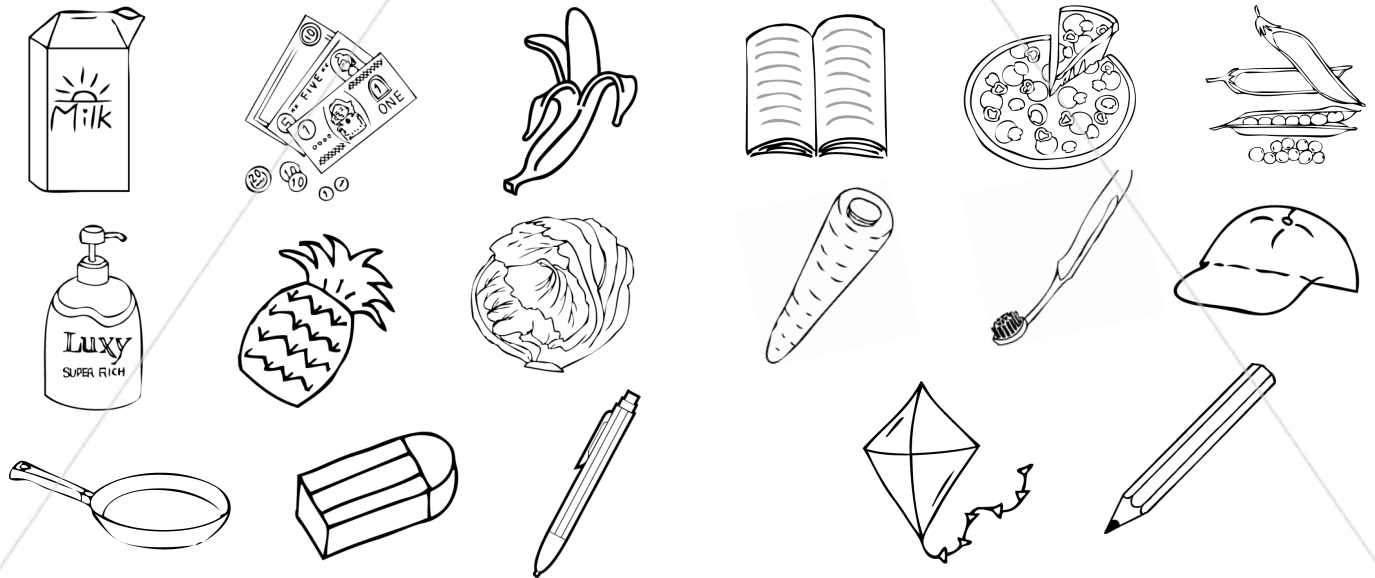

Shopping

My name is _____

t	c	f	c	b	a	n	a	n	a	s	m	w	c	o
c	t	p	a	b	a	f	r	y	i	n	g	p	a	n
e	c	o	p	y	a	n	k	r	b	q	d	h	r	g
r	q	r	o	z	o	o	o	u	c	k	z	f	r	y
e	u	y	v	t	k	t	d	b	f	d	c	h	o	t
a	a	w	m	k	h	e	i	b	h	b	l	b	t	r
l	s	p	o	b	c	b	l	e	h	p	e	f	t	h
f	h	i	n	k	g	o	r	r	q	e	t	h	y	m
c	a	n	e	i	z	o	w	u	p	a	t	z	i	s
s	m	e	y	t	s	k	j	p	s	s	u	h	q	w
p	p	a	c	e	p	e	n	q	o	h	c	b	u	t
e	o	p	m	d	u	l	k	q	m	v	e	p	e	s
v	o	p	f	n	p	e	n	c	i	l	c	a	s	e
t	c	l	o	d	t	a	p	m	l	g	p	x	p	l
p	k	e	h	p	i	z	z	a	k	p	j	e	b	f

SAMPLE FOR EVALUATION
 Join ESL KidStuff
 to print without watermark

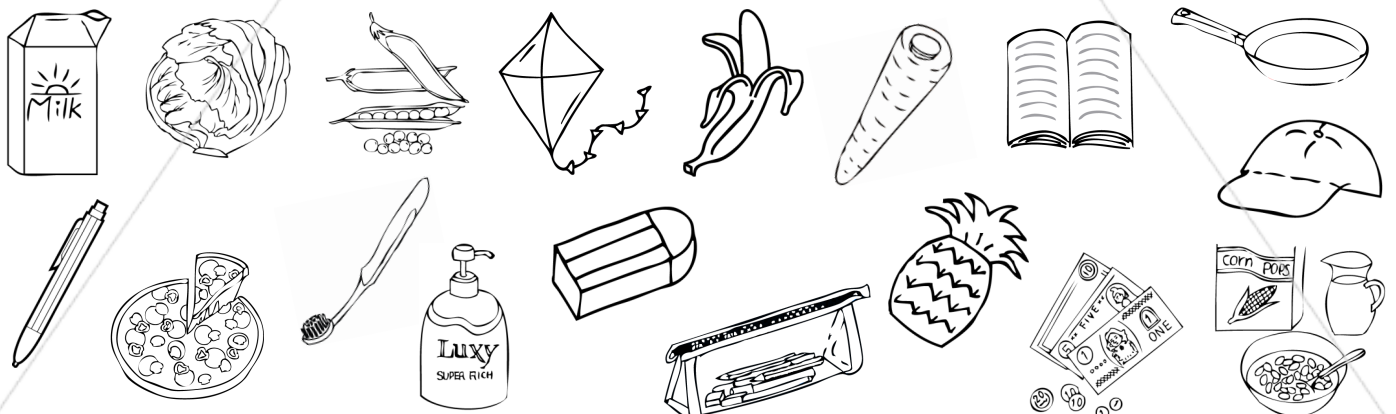

Shopping

ANSWERS

t	c	f	c	b	a	n	a	n	a	s	m	w	c	o
c	t	p	a	b	a	f	r	y	i	n	g	p	a	n
e	c	o	p	y	a	n	k	r	b	q	d	h	r	g
r	q	r	o	z	o	o	o	u	c	k	z	f	r	y
e	u	y	v	t	k	t	d	b	f	d	c	h	o	t
a	a	w	m	k	h	e	i	b	h	b	l	b	t	r
l	s	p	o	b	c	b	l	e	h	p	e	f	t	h
f	h	i	n	k	g	o	r	r	q	e	t	h	y	m
c	a	n	e	i	z	o	w	u	p	a	t	z	i	s
s	m	e	y	t	s	k	j	p	s	s	u	h	q	w
p	p	a	c	e	p	e	n	q	o	h	c	b	u	t
e	o	p	m	d	u	l	k	q	m	v	e	p	e	s
v	o	p	f	n	p	e	n	c	i	l	c	a	s	e
t	c	l	o	d	t	a	p	m	l	g	p	x	p	l
p	k	e	h	p	i	z	z	a	k	p	j	e	b	f

SAMPLE FOR EVALUATION
 Join ESL KidStuff
 to print without watermark

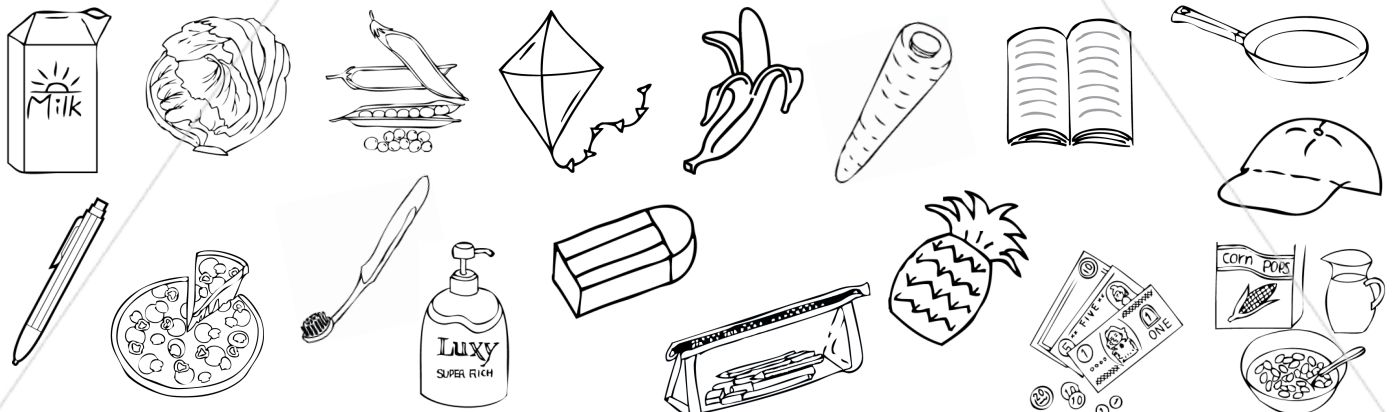

Let's go shopping My name is _____

(GB English version)

Seo-yun and David went shopping. Read what they bought. Calculate who spent the most money.

I bought...

- | | |
|-------------------------|--------------------------|
| - 5 pizzas _____ | - 10 apples _____ |
| - 8 bananas _____ | - 4 milk cartons _____ |
| - 2 notebooks _____ | - 6 pea pods _____ |
| - 1 pair of shoes _____ | |
| - 5 soaps _____ | It is a total of £ _____ |



£ 4



£ 2



£ 3

SAMPLE FOR EVALUATION

Join ESL KidStuff
to print without watermark



£ 21



£ 6

£ 8



£ 1



£ 1

£ 80



£ 22



£ 3

£ 1



I bought...

- | | |
|------------------------|--------------------------|
| - 3 pizzas _____ | - 1 ball _____ |
| - 6 milk cartons _____ | - 1 cap _____ |
| - 2 notebooks _____ | - 2 pea pods _____ |
| - 1 apple _____ | |
| - 2 soaps _____ | It is a total of £ _____ |